





CIJENIK PRIBORA ZA MONTAŽU I ODRŽAVANJE KLIMA UREĐAJA

ŠIFRA	NAZIV	KATALOG	JM	VPC	MPC	
BAKRENE CIJEVI SA IZOLACIJOM						
7436	BAKRENA CIJEV IZOL. 1/4" 6mm SCT		m	3,25 KM	3,80 KM	
7528	BAKRENA CIJEV IZOL. 3/8" 10mm SCT		m	5,00 KM	5,85 KM	
7437	BAKRENA CIJEV IZOL. 1/2" 12mm SCT		m	6,75 KM	7,90 KM	
7527	BAKRENA CIJEV IZOL. 5/8" 16mm SCT		m	10,43 KM	12,20 KM	
7529	BAKRENA CIJEV IZOL. 3/4" 18mm SCT		m	12,65 KM	14,80 KM	
11126	BAKRENA CIJEV IZOL. 7/8" 22mm SCT		m	15,13 KM	17,70 KM	
CIJEVI ZA ODVOD KONDENZATA FLEX						
10926	CIJEV ZA ODVOD KONDENZATA 16mm 30m		9899-057-01X	m	0,60 KM	0,70 KM
7760	CIJEV ZA ODVOD KONDENZATA 16/18mm		9899-053-01	m	0,90 KM	1,05 KM
7636	CIJEV ZA ODVOD KONDENZATA 18mm 30m		9899-056-01	Kom	30,00 KM	35,10 KM
7761	CIJEV ZA ODVOD KONDENZATA 18/20mm		9899-052-01	m	0,98 KM	1,15 KM
6673	CIJEV ZA ODVOD KONDENZATA 25mm		9899-058-01	Kom	45,00 KM	52,65 KM
7751	CIJEV ZA ODVOD KONDENZATA 20mm 30m		9899-055-01	m	0,68 KM	0,80 KM
8674	CIJEV ZA ODVOD KONDENZATA 32mm	9899-068-01	m	2,44 KM	2,85 KM	
5103	CIJEV ZA ODVOD KONDENZATA 16mm 55M Tecnosistemi	5750TS5915	Kom	80,00 KM	93,60 KM	
CIJEVI ZA ODVOD KONDENZATA TVRDA						
7013	PVC CIJEV F20mm VECAM		9899-040-08	m	1,28 KM	1,50 KM
7162	PVC CIJEV F25mm VECAM		9899-110-08	m	2,35 KM	2,75 KM
2594	PVC CIJEV F32mm VECAM		9899-120-08	m	2,78 KM	3,25 KM
NOSAČI KLIMA						
12734	NOSAČ KLIME NKL-1/9 (pocinčani mali)			Par	8,55 KM	10,00 KM
6999	NOSAČ KLIME NKL-2 (pocinčani veliki)			Par	19,66 KM	23,00 KM
7752	NOSAČ KLIME 380x400mm 110kg		9794-057X	Par	18,46 KM	21,60 KM
7635	NOSAČ KLIME 520x400mm 150kg		9794-145	Par	26,88 KM	31,45 KM
1680	NOSAČ KLIME 520x450mm 150kg PVC		9794-512-08	Par	29,83 KM	34,90 KM
8124	NOSAČ KLIME 450x400x800+LIVER 70kg		9794-021	Par	20,47 KM	23,95 KM
1055	NOSAČ KLIME 560x400mm 150kg		9794-146	Par	30,68 KM	35,90 KM
3418	NOSAČ KLIME 600x400mm 150kg		9794-147	Par	40,60 KM	47,50 KM
6879	NOSAČ KLIME STROPNI 90kg		9794-016	Par	75,00 KM	87,75 KM
2737	NOSAČ KLIMA PODNI 420mm		9898-033-01	Kom	5,13 KM	6,00 KM
1101	NOSAČ KLIME 300x100x520 podni		9898-040	Kom	85,00 KM	99,45 KM
8573	NOSAČ KLIME 480x1000		9794-004	Par	52,14 KM	61,00 KM
11962	NOSAČ KLIME 450x450mm 140kg		9794-161	Kom	16,24 KM	19,00 KM
11963	NOSAČ KLIME 500x450mm 140kg	9794-162	Kom	18,25 KM	21,35 KM	
11964	NOSAČ KLIME 600x500mm 140kg	9794-163	Kom	20,17 KM	23,60 KM	
12443	NOSAČ KLIME 750x500mm 100kg	9794-165	Kom	27,35 KM	32,00 KM	

12808	NOSAČ KLIME PODNI 1000X150X95 560kg		9898-055-095	Kom	53,85 KM	63,00 KM
12805	NOSAČ KLIME PODNI 250X160X90 300kg		9898-051-95	Kom	17,95 KM	21,00 KM
12810	NOSAČ KLIME PODNI 400X130X60 360kg		9898-052-095	Kom	19,66 KM	23,00 KM
12809	NOSAČ KLIME PODNI 500X130X60 400kg		9898-050-095	Kom	23,08 KM	27,00 KM

NOGE ZA KLIMU

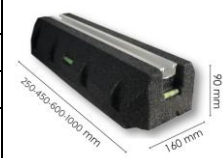
1292	NOGA 9898-045		9898-045	Kom	17,09 KM	20,00 KM
1103	NOGA 9898-041		9898-041	Kom	34,19 KM	40,00 KM
1293	NOGA 9898-042		9898-042	Kom	25,64 KM	30,00 KM

PVC KANALICE

10879	KANALICA CLIMA PLUS PVC 25x25		9809-001-08	m	1,71 KM	2,00 KM
7762	KANALICA CLIMA PLUS PVC 35x30		9810-001-08	m	2,18 KM	2,55 KM
7763	KANALICA CLIMA PLUS PVC 65x50		9801-001-08	m	3,76 KM	4,40 KM
10220	KANALICA CLIMA PLUS PVC 70x55		9804-001-08	m	3,33 KM	3,90KM
10221	KANALICA CLIMA PLUS PVC 80x60		9805-001-08	m	4,53 KM	5,30 KM
10222	KANALICA CLIMA PLUS PVC 90x65		9802-001-08	m	5,13 KM	6,00 KM
10537	KANALICA CLIMA PLUS PVC 125x75		9803-001-08	m	9,02 KM	10,55 KM
6796	PVC KANALICA ECO LINE T- 60 60*52mm/ 2m/kom	5701TS1020	Kom	12,22 KM	14,30 KM	
6797	PVC KANALICA ECO LINE T- 72 72*64mm/ 2m/kom	5701TS1025	Kom	14,19 KM	16,60 KM	
6798	PVC KANALICA ECO LINE T-100 98*83mm/ 2m/kom	5701TS1030	Kom	22,65 KM	26,50 KM	





PVC REDUCIRKE

7759	REDUCIRKA 16mm (trodijelna)		9899-177-01	kom	2,56 KM	3,00 KM
7758	REDUCIRKA 16mm (T-komad)		9899-174-01	kom	2,56 KM	3,00 KM
10243	REDUCIRKA (T-komad) 90x65 PVC		9802-200-08	kom	4,66 KM	5,45 KM
10549	T REDUKCIJA 80x60 PVC		9805-200-08	kom	1,84 KM	2,15 KM
10548	T REDUKCIJA 125x75 PVC		9803-200-08	kom	3,25 KM	3,80 KM
7757	REDUCIRKA KONDENZATA 16mm/90C	9899-172-01	kom	3,12 KM	3,65 KM	
7756	REDUCIRKA KONDENZATA	9899-171-01	kom	2,31 KM	2,70 KM	
7754	REDUCIRKA KONDENZATA 16/16	9899-141-01	kom	1,71 KM	2,00 KM	
7755	REDUCIRKA KONDENZATA 20/16	9899-140-01	kom	1,71 KM	2,00 KM	
10842	REDUKCIJA 80x65 PVC		9801-202-08	kom	2,14 KM	2,50 KM
10244	REDUKCIJA 80x70 PVC		9804-202-08	kom	2,14 KM	2,50 KM
10245	REDUKCIJA 90x65 PVC		9802-201-08	kom	2,39 KM	2,80 KM
10246	REDUKCIJA 90x70 PVC		9804-201-08	kom	2,48 KM	2,90 KM
10843	REDUKCIJA 125x80 PVC		9805-201-08	kom	2,48 KM	2,90 KM
10847	REDUKCIJA 125x90 PVC		9803-201-08	kom	2,48 KM	2,90 KM

PVC ADAPTERI I KUTNICI

7753	ADAPTER DVODIJELNI 16/16		9899-142-01	kom	1,88 KM	2,20 KM
8330	FLEKSIBILNA CIJEV ZA KANALICE 65x50		9801-118-08	kom	18,29 KM	21,40 KM
10844	Fleksibilna cijev za kanalice 70X55		9804-118-08	kom	25,00 KM	29,25 KM
10845	FLEKSIBILNA CIJEV ZA KANALICE 80x60		9805-118-08	kom	25,64 KM	30,00 KM
10846	FLEKSIBILNA CIJEV ZA KANALICE 90x65		9802-118-08	kom	25,64 KM	30,00 KM
10547	KUTNIK ZA KANALICU 25x25		9809-115-08	kom	1,28 KM	1,50 KM

10691	KUTNIK ROZETNA ZA KANALICU 35x30		9810-102-08	kom	4,10 KM	4,80 KM
10538	KUTNIK UNUTARNJI ZA KANALICU 35x30		9810-112-08	kom	1,37 KM	1,60 KM
10541	KUTNIK ZA KANALICU 35x30		9810-113-08	kom	1,37 KM	1,60 KM
10685	KUTNIK ZA KANALICU 35x30		9810-114-08	kom	1,45 KM	1,70 KM
10550	KUTNIK ZA KANALICU 35X30		9810-115-08	kom	0,94 KM	1,10 KM
10686	KUTNIK ROZETNA ZA KANALICU 65x50		9801-103-08	kom	1,71 KM	2,00 KM
8332	KUTNIK ZA KANALICU 65x50 45-135°C		9801-117-08	kom	6,71 KM	7,85 KM

8333	KUTNIK ZIDNI ZA KANALICU 65X50		9801-116-08	kom	2,91 KM	3,40 KM
8334	KUTNIK ZA KANALICU 65X50		9801-115-08	kom	2,44 KM	2,85 KM
8335	KUTNIK ZA KANALICU 65x50		9801-114-08	kom	2,14 KM	2,50 KM
8336	KUTNIK ZA KANALICU 65x50		9801-113-08	kom	2,56 KM	3,00 KM
8337	KUTNIK UNUTARNJI ZA KANALICU 65X50		9801-112-08	kom	2,56 KM	3,00 KM
10547	KUTNIK ZA KANALICU 80x60		9805-117-08	kom	7,78 KM	9,10 KM
ŠIFRA	NAZIV		KATALOG	JM	VPC	MPC
8338	KUTNIK ROZETNA ZA KANALICU 65x50		9801-111-08	kom	2,22 KM	2,60 KM
10692	KUTNIK ROZETNA ZA KANALICU 65x50		9801-102-08	kom	1,20 KM	1,40 KM
10899	KUTNIK ZA KANALICU 65x50 D200-700mm		9801-203-08	kom	19,23 KM	22,50 KM
10693	KUTNIK ROZETNA ZA KANALICU 70x55		9804-102-08	kom	1,20 KM	1,40 KM
10687	KUTNIK ROZETNA ZA KANALICU 70x55		9804-103-08	kom	2,05 KM	2,40 KM
10553	KUTNIK ZA KANALICU 70x55 45-135°		9804-117-08	kom	7,31 KM	8,55 KM
10223	KUTNIK ZA KANALICU 70X55		9804-114-08	kom	2,48 KM	2,90 KM
10226	KUTNIK UNUTARNJI ZA KANALICU 70X55		9804-112-08	kom	2,48 KM	2,90 KM
10229	KUTNIK ZA KANALICU 70X55		9804-113-08	kom	2,48 KM	2,90 KM
10232	KUTNIK ROZETNA ZA KANALICU 70X55		9804-111-08	kom	2,22 KM	2,60KM
10235	KUTNIK ZA KANALICU 70X55		9804-115-08	kom	2,48 KM	2,90 KM
10238	KUTNIK ZIDNI ZA KANALICU 70X55		9804-116-08	kom	2,65 KM	3,10 KM
10900	KUTNIK ZA KANALICU 70x55 D200-700mm		9804-203-08	kom	26,92 KM	31,50 KM
10694	KUTNIK ROZETNA ZA KANALICU 80x60		9805-102-08	kom	1,37 KM	1,60 KM
10688	KUTNIK ROZETNA ZA KANALICU 80x60		9805-103-08	kom	2,22 KM	2,60 KM
10224	KUTNIK ZA KANALICU 80X60		9805-114-08	kom	2,37 KM	2,70 KM
10227	KUTNIK UNUTARNJI ZA KANALICU 80X60		9805-112-08	kom	2,99 KM	3,50 KM
10230	KUTNIK ZA KANALICU 80X60		9805-113-08	kom	2,99 KM	3,50 KM
10233	KUTNIK ROZETNA ZA KANALICU 80X60		9805-111-08	kom	2,22 KM	2,60KM
10236	KUTNIK ZA KANALICU 80X60		9805-115-08	kom	2,82 KM	3,30 KM
10239	KUTNIK ZIDNI ZA KANALICU 80X60		9805-116-08	kom	3,29 KM	3,85 KM
10556	KUTNIK ZA KANALICU 80x60 45-135°		9805-117-08	kom	7,78 KM	9,10 KM
10901	KUTNIK ZA KANALICU 80x60 D200-700mm		9805-203-08	kom	20,00 KM	23,40 KM
10695	KUTNIK ROZETNA ZA KANALICU 90x65		9802-102-08	kom	1,41 KM	1,65 KM
10689	KUTNIK ROZETNA ZA KANALICU 90x65		9802-103-08	kom	2,48 KM	2,90 KM
10555	KUTNIK ZA KANALICU 90x65 45-135°		9802-117-08	kom	7,78 KM	9,10 KM
10225	KUTNIK ZA KANALICU 90X65		9802-114-08	kom	2,86 KM	3,35 KM
10228	KUTNIK UNUTARNJI ZA KANALICU 90X65		9802-112-08	kom	3,42 KM	4,00 KM
10231	KUTNIK ZA KANALICU 90X65		9802-113-08	kom	3,50 KM	4,10 KM
10234	KUTNIK ROZETNA ZA KANALICU 90X65		9802-111-08	kom	2,48 KM	2,90 KM
10237	KUTNIK ZA KANALICU 90X65	9802-115-08	kom	2,78 KM	3,25 KM	

10240	KUTNIK ZIDNI ZA KANALICU 90X65	9802-116-08	kom	4,06 KM	4,75 KM	
10902	KUTNIK ZA KANALICU 90x65 D200-700mm	9802-203-08	kom	19,66 KM	23,00 KM	
10696	KUTNIK ROZETNA ZA KANALICU 125x75		9803-102-08	kom	1,54 KM	1,80 KM
10546	KUTNIK ROZETNA ZA KANALICU 125x75		9803-111-08	kom	2,39 KM	2,80 KM
10539	KUTNIK ROZETNA ZA KANALICU 125x75		9803-112-08	kom	3,25 KM	3,80 KM
10543	KUTNIK ZA KANALICU 125x75		9803-113-08	kom	3,25 KM	3,80 KM
10545	KUTNIK ZA KANALICU 125x75		9803-114-08	kom	3,08 KM	3,60 KM
10551	KUTNIK ZA KANALICU 125x75		9803-115-08	kom	3,38 KM	3,95 KM
10552	KUTNIK ZIDNI ZA KANALICU 125x75		9803-116-08	kom	3,50 KM	4,10 KM

PVC KUTNIK

7926	PVC KUTNIK 45 F20mm VECAM		9899-043-08	kom	1,92 KM	2,25 KM
10826	PVC KUTNIK 45 F25mm VECAM		9899-113-08	kom	2,22 KM	2,60 KM
6976	PVC KUTNIK 90 F20mm VECAM		9899-042-08	kom	1,37 KM	1,60 KM
7163	PVC KUTNIK 90 F25mm VECAM		9899-112-08	kom	1,37 KM	1,60 KM
10827	PVC KUTNIK 45 F32mm VECAM		9899-123-08	kom	2,22 KM	2,60 KM
ŠIFRA	NAZIV	KATALOG	JM	VPC	MPC	
7692	PVC KUTNIK 90 F32mm VECAM		9899-122-08	kom	2,14 KM	2,50 KM
10853	PVC KUTNIK T F20mm VECAM		9899-044-08	kom	2,14 KM	2,50 KM
10420	PVC KUTNIK T F25mm VECAM		9899-114-08	kom	2,56 KM	3,00 KM
10865	PVC KUTNIK T F32mm VECAM		9899-124-08	kom	2,99 KM	3,50 KM
5417	PVC SPOJKA F25mm VECAM		9899-111-08	kom	2,14 KM	2,50 KM

PVC PODRŠKA I NASTAVAK ZA PVC KANALICU

10881	PVC PODRŠKA ZA PVC KANALICU 65x50 CLIMA PLUS	9801-101-00	kom	0,81 KM	0,95 KM
10882	PVC PODRŠKA ZA PVC KANALICU 70x55 CLIMA PLUS	9804-101-00	kom	0,81 KM	0,95 KM
10883	PVC PODRŠKA ZA PVC KANALICU 80x60 CLIMA PLUS	9805-101-00	kom	0,81 KM	0,95 KM
10884	PVC PODRŠKA ZA PVC KANALICU 90x65 CLIMA PLUS	9802-101-00	kom	0,81 KM	0,95 KM
10885	PVC PODRŠKA ZA PVC KANALICU 65x50 EURO PLUS	9811-101-00	kom	0,81 KM	0,95 KM
10886	PVC PODRŠKA ZA PVC KANALICU 70x55 EURO PLUS	9814-101-00	kom	0,81 KM	0,95 KM
10887	PVC PODRŠKA ZA PVC KANALICU 80x60 EURO PLUS	9815-101-00	kom	0,81 KM	0,95 KM
10888	PVC PODRŠKA ZA PVC KANALICU 90x65 EURO PLUS	9812-101-00	kom	0,81 KM	0,95 KM
10904	PVC NASTAVAK F20/20	9899-046-08	kom	1,71 KM	2,00 KM
10905	PVC NASTAVAK F20/25	9899-116-08	kom	2,39 KM	2,80 KM

PVC NOSAČI, REDUCIRKE I SPOJKE

10868	PVC NOSAČ CIJEVI F20mm VECAM		9899-045-08	kom	0,81 KM	0,95 KM
10869	PVC NOSAČ CIJEVI F25mm VECAM		9899-115-08	kom	0,81 KM	0,95 KM
10870	PVC NOSAČ CIJEVI F32mm VECAM		9899-125-08	kom	0,81 KM	0,95 KM
10866	PVC REDUCIRKA F25-20mm VECAM		9899-117-08	kom	2,35 KM	2,75 KM
10867	PVC REDUCIRKA F32-25mm VECAM		9899-127-08	kom	2,86 KM	3,35 KM
4817	PVC SPOJKA F20mm VECAM		9899-041-08	kom	1,88 KM	2,20 KM
6565	PVC SPOJKA F32mm VECAM		9899-121-08	kom	2,22 KM	2,60 KM

TABLETE I SREDSTVA ZA ČIŠĆENJE I DEZINFEKCIJU

3946	ACTABS TABLETE - 40 kom			kom	29,06 KM	34,00 KM
6532	ACTABS TABLETE - 80 kom			kom	51,28 KM	60,00 KM
3952	ACTABS TABLETE - 200 kom			kom	111,11 KM	130,00 KM
6533	COIL DISINFECTANT V-1 0,5L (mirisni)			kom	14,10 KM	16,50 KM

6527	COIL DISINFECTANT V-1 2 L (mirisni)			kom	35,90 KM	42,00 KM
6538	COIL DISINFECTANT V-1 5 L (mirisni)			kom	76,92 KM	90,00 KM
2089	CLEAN SAFE 5 L			kom	80,00 KM	93,60 KM
7005	CLEAN-N-SAFE (aerosol)			kom	21,71 KM	25,40 KM
9029	CLEAN-N-SAFE KOMPLET ZA ČIŠĆENJE			kom	35,00 KM	40,95 KM
5610	FOAM-A-COIL (aerosol)			kom	19,49 KM	22,80 KM
6529	FOAM-A-COIL 2 L mirisni			kom	42,31 KM	49,50 KM
6530	FOAM-A-COIL 5 L mirisni			kom	84,19 KM	98,50 KM
9030	FOAM-A-COIL KOMPLET ZA ČIŠĆENJE			kom	37,31 KM	43,65 KM

TAVE ZA SKUPLJANJE VODE KONDENZATA

10241	TAVA 790x390x30mm ZA SKUPLJANJE VODE KONDENZATA	9794-013-06	kom	61,54 KM	72,00 KM
10242	TAVA 945x425x40mm ZA SKUPLJANJE VODE KONDENZATA	9794-014-06	kom	75,00 KM	87,75 KM
10890	TAVA 790x390x40mm ZA KONDENZAT SA GRIJAČEM	9899-401-01	kom	195,00 KM	228,15 KM
10889	TAVA 945x425x45mm ZA KONDENZAT SA GRIJAČEM	9899-400-01	kom	200,00 KM	234,00 KM
ŠIFRA	NAZIV	KATALOG	JM	VPC	MPC
10242	TAVA 945x425x40mm ZA KONDENZAT	9794-014-06	kom	75,00 KM	87,75 KM
8930	POKLOPAC KLIME 1000x500x180	9898-100-06	Kom	95,00 KM	111,15 KM

INSTALACIJSKE KUTIJE

8675	KUTIJA (instalacijska) 430x108x65		9899-029-01	kom	8,12 KM	9,50 KM
9574	KUTIJA (instalacijska)430x108x50		9899-033-01	kom	6,54 KM	7,65 KM

LULE ZA ODVOD KONDEZATA

2539	LULA ODVODA KONDENZATA 19		9899-109	kom	4,83 KM	5,65 KM
2711	LULA ODVODA KONDENZATA 32		9899-108	kom	4,83 KM	5,65 KM
11238	LULA ZA ODVOD KOND. DAIKIN		058956J	kom	5,13 KM	6,00 KM

ALATI

3298	PVC NOŽ ZA OBRADU CIJEVI VECAM	9002-925	kom	11,07 KM	12,95 KM
10880	KLIJEŠTA ZA PVC KANALICE VECAM	9899-990	kom	175,00 KM	204,75 KM
10907	TORBICA KLIJEŠTA ZA PVC KANALICE VECAM	9899-992	kom	40,00 KM	46,80 KM
10871	LJEPILO ZA PVC CIJEVI VECAM	9899-047-08	kom	10,68 KM	12,50 KM

ŠARAFI

7764	VIJAK NOSAČA KLIME (PVC)		9898-008-95	kom	6,75 KM	7,90 KM
8325	SET ŠARAFI + TIPLOVI		G10-463	set	5,98 KM	7,00 KM
8326	SET ŠARAFI + TIPLOVI		G10-464	kom	6,84 KM	8,00 KM

IZOLACIJA



8283	IZOLACIJSKA TRAKA 50x3x10 BIJELA 10m		ISL500UN	kom	5,51 KM	6,45 KM
8284	IZOLACIJSKA TRAKA 50x3x15 CRNA 15m		ISL510UN	kom	10,00 KM	11,70 KM
11300	ALUMINIJSKA TRAKA 50x0,3mmx50m		9898-401	kom	12,82 KM	15,00 KM
11299	ALUMINIJSKA TRAKA 50x0,3mmx50m		9898-400	kom	12,82 KM	15,00 KM

LIVER

7765	LIVER ALUMINIJSKI 1000x30x10mm	9794-510	kom	78,72 KM	92,10 KM
------	--------------------------------	----------	-----	----------	----------

SIFONI

10247	SIFON	9899-242-01	kom	19,23 KM	22,50 KM
2442	SIFON	30234	kom	10,17 KM	11,90 KM

REDUCIRKE						
5460	REDUCIRKA ½ G*1/4 SEA 19803 CASTEL		5552RF2250	Kom	6,92 KM	8,10 KM
5129	REDUCIRKA ½ SAE* ½ SAE 7110/4 CASTEL		5552XX0106	Kom	3,72 KM	4,35 KM
7564	REDUCIRKA ½ SAE* 5/8 SAE CASTEL		5552XX0208	Kom	10,60 KM	12,40 KM
4083	REDUCIRKA ¼ SAE 816/2 WIGAM		5552XX9002	Kom	5,64 KM	6,60 KM
5769	REDUCIRKA ¼ SAE * ¼ NPT 8354/22 CASTEL		5552XX2200	Kom	1,62 KM	1,90 KM
5127	REDUCIRKA ¼ SAE* ¼ SAE 7110/2 CASTEL		5552XX0102	Kom	1,54 KM	1,80 KM
1847	REDUCIRKA ¼ * ½ 7120/24 CASTEL		5552XX0204	Kom	5,68 KM	6,65 KM
1846	REDUCIRKA ¼ * 3/8 7120/23 CASTEL	5552XX0202	Kom	3,93 KM	4,60 KM	
5128	REDUCIRKA 3/8 SAE*3/8 SAE 7110/3 CASTEL	5552XX0104	Kom	2,44 KM	3,00 KM	
2154	REDUCIRKA 3/8 SAE * ½ SAE 7120/34 CASTEL		5552XX0206	Kom	6,24 KM	7,55 KM
5130	REDUCIRKA 5/8 * 5/8 7110/5 CASTEL		5552XX0108	Kom	5,34 KM	6,25 KM
6312	REDUCIRKA K ½ SAE * 3/8 SAE REFCO		5552RF3110	Kom	11,71 KM	13,70 KM
ŠIFRA	NAZIV	KATALOG	JM	VPC	MPC	
6307	REDUCIRKA K ¼ SAE * ¼ NPT 7220/2 CASTEL	5552XX3053	Kom	3,03 KM	3,55 KM	
9099	REDUCIRKA K ¼ SAE * ¼ SAE CASTEL 7210/2	5552XX3010	Kom	3,76 KM	4,40 KM	
6310	REDUCIRKA K 3/8 SAE * ¼ SAE REFCO	5552RF3100	Kom	7,86 KM	9,20 KM	
5253	REDUCIRKA TEE ¼-1/4 SAE1/8NPT 7330/221 CASTEL	5552XX4332	Kom	3,59 KM	4,20 KM	
6309	REDUCIRKA TEE 3/8*3/8*1/2 SAE REFCO	5552RF3015	Kom	15,47 KM	18,10 KM	
6249	REDUCIRKA TEE 3/8*3/8*1/4 SAE REFCO	5552RF3005	Kom	14,53 KM	17,00 KM	
HOLENDER MATICE						
3521	HOLENDER MATICA 6mm – ¼ SAE CASTEL	 	5551XX1011	Kom	0,77 KM	0,90 KM
3161	HOLENDER MATICA 6mm – 3/8 SAE CASTEL		5551XX1013	Kom	1,37 KM	1,60 KM
1054	HOLENDER MATICA 8mm – 3/8 SAE CASTEL		5551XX1023	Kom	1,28 KM	1,50 KM
161	HOLENDER MATICA 10mm – ½ SAE CASTEL		5551XX1034	Kom	2,01 KM	2,35 KM
896	HOLENDER MATICA 10mm – 3/8 SAE CASTEL		5551XX1033	Kom	1,28 KM	1,50 KM
1053	HOLENDER MATICA 12mm – ½ SAE CASTEL		5551XX1035	Kom	1,84 KM	2,15 KM
6911	HOLENDER MATICA 12mm – 5/8 SAE CASTEL		5551XX1044	Kom	2,52 KM	2,95 KM
950	HOLENDER MATICA 16mm – 5/8 SAE CASTEL		5551XX1055	Kom	2,35 KM	2,75 KM
938	HOLENDER MATICA 18mm – ¾ SAE CASTEL		5551XX1063	Kom	4,02 KM	4,70 KM
6448	HOLENDER MATICA 22mm – 7/8 SAE CASTEL		5551XX1088	Kom	9,57 KM	11,20 KM
6791	HOLENDER MATICA ½"-1/2 SAE CASTEL	5551XX1036	Kom	1,84 KM	2,15 KM	
9720	HOLENDER MATICA ¾" – ¾ SAE CASTEL	5551XX1066	Kom	3,89 KM	4,55 KM	
6792	HOLENDER MATICA 3/8" – 3/8 SAE CASTEL	5551XX1032	Kom	1,28 KM	1,50 KM	
PROVODNIK						
11657	PROVODNIK A03VV-F 5G0,75 wh RAL 9010 licnasti	3012006C	M	0,77 KM	0,90 KM	
10013	PROVODNIK H05VV-F 3G1,5 wh RAL 9010 licnasti	3011014C	M	0,90 KM	1,05 KM	
10014	PROVODNIK H05VV-F 3G2,5 wh RAL 9010 licnasti	3211016C	M	1,45 KM	1,70 KM	
10010	PROVODNIK H05VV-F 5G0,75 wh RAL 9010 licnasti	3011030C	M	0,77 KM	0,90 KM	
10015	PROVODNIK H05VV-F 5G1,5 wh RAL 9010 licnasti	3011034C	M	1,45 KM	1,70 KM	
11656	PROVODNIK H05VV-F 5G2,5 wh 9010 licnasti	3011036C	M	2,31 KM	2,70 KM	
9098	PROVODNIK PP/L 3X0,75/(100m) HO3VV licnasti	11009	M	0,47 KM	0,55 KM	
10008	PROVODNIK YM-J 3X1,5 RE gy tvrdi	3002002C	M	0,77 KM	0,90 KM	
10011	PROVODNIK YM-J 3X2,5 RE gy tvrdi	3202003C	M	1,15 KM	1,45 KM	
10012	PROVODNIK YM-J 5X2,5 RE gy tvrdi	3002016C	M	1,24 KM	1,45 KM	
10009	PROVODNIK YM-J 5X2,5 RE gy tvrdi	3002017C	M	2,05 KM	2,40 KM	

-DETALJNE KARAKTERISTIKE OPREME IZ CIJENIKA

MOŽETE POGLEDATI NA INTERNET STRANICI

www.sctubes.com

www.vecamco.it

www.castel.it

www.rectorseal.com

www.niccons.com

www.refco.ch

ILI NA GOOGLE UPIŠETE KATALOŠKI BROJ.

-RABAT NA OPREMU: PO DOGOVORU

-NAČIN PLAĆANJA: PO DOGOVORU

Zadržavamo pravo promjene cijena bez prethodne najave.